

Installation Instructions

Ground Fixed

Babel Drum
Page 1 of 3



Instrument
Components:



Metric Conversion:
200mm/ 8"
400mm/ 16"
530mm/ 20 55/64"
680mm/ 26 49/64"
700mm/ 27 9/16"
850mm/ 33 15/32"
980mm/ 38 37/64"
1.5m/ 59"

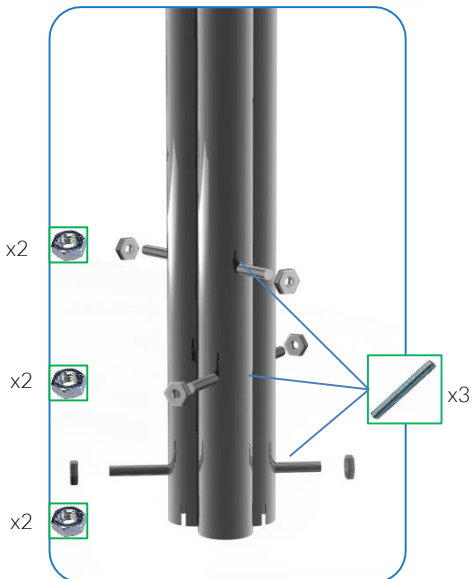

Weight of heaviest part **17.5kg** (Large Babel Drum)
Weight of heaviest part **13.4kg** (Small Babel Drum)

1. Unpack ground fixing legs 3no.

2. Lay packaging out on floor or assemble on non-abrasive surface to prevent marking of polished stainless steel.

3. Align holes on legs (opposite end to polished domes) and secure in place using 3no. M10 x 200mm threaded bar and 6no. M10 nuts provided
Tools required 2no. 17mm metric spanner/wrench (¹¹/₁₆ inch or alternatively using adjustable wrench)

4. Invert assembled frame so domed ends face upwards.

5. Place 8mm Hex Key supplied into hole in leg and lock into internal bolt.

6. Remove Black caps opposite side of leg and keeping Hex Key in place, slide black polyurethane damper over bolt until flush with end of bolt. Repeat for other 2 legs

7. Unpack babel drum leaving black film in place to protect.

8. Align holes in side of babel drum with bolts on legs.

9. Using 8mm Hex Key screw bolts into drum to secure in place.
Use thread locking solution
All hole locations are laser cut for accuracy to ensure holes in drum align perfectly with legs.

10. Using TX40 driver provided secure M8 x 25mm security bolts into external holes in legs 3no. Use thread lock solution

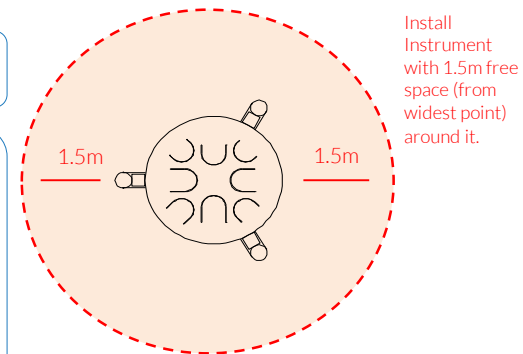

CAUTION: Drum surface can get hot in direct sunlight, if possible install in shaded areas.

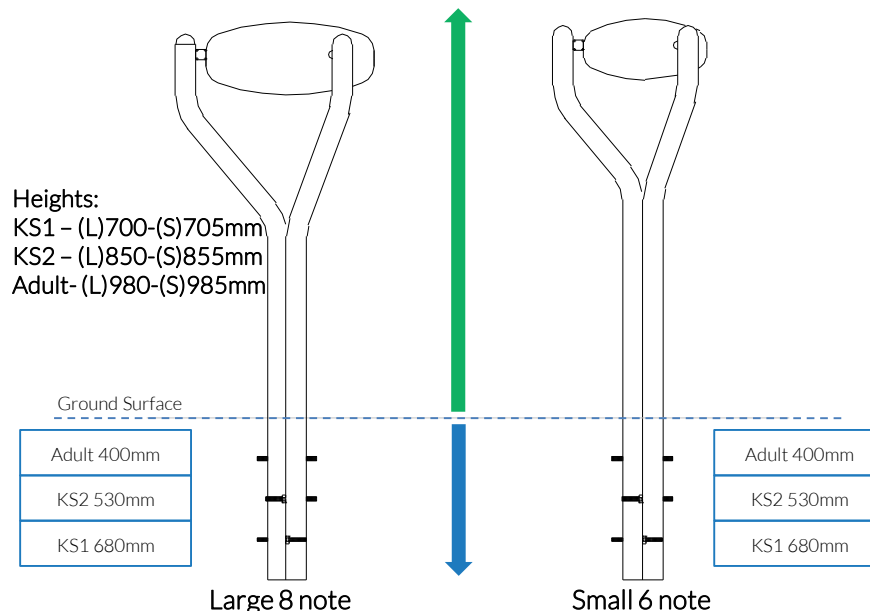

Ground Fix
Components:

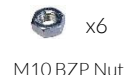

Spares available from
www.musical-play.com or
from your local distributor

22 Kg
13.4 Kg

Assembly Guide PPBDL-S

Tools:



x1 Hex T Key x1 TX 40 Driver Bit

Ground Fixed

Babel Drum
Page 2 of 3



Instrument Components:



x3
M8x25mm Pin Torx

Thread Lock Solution
Required

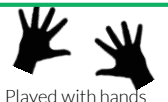
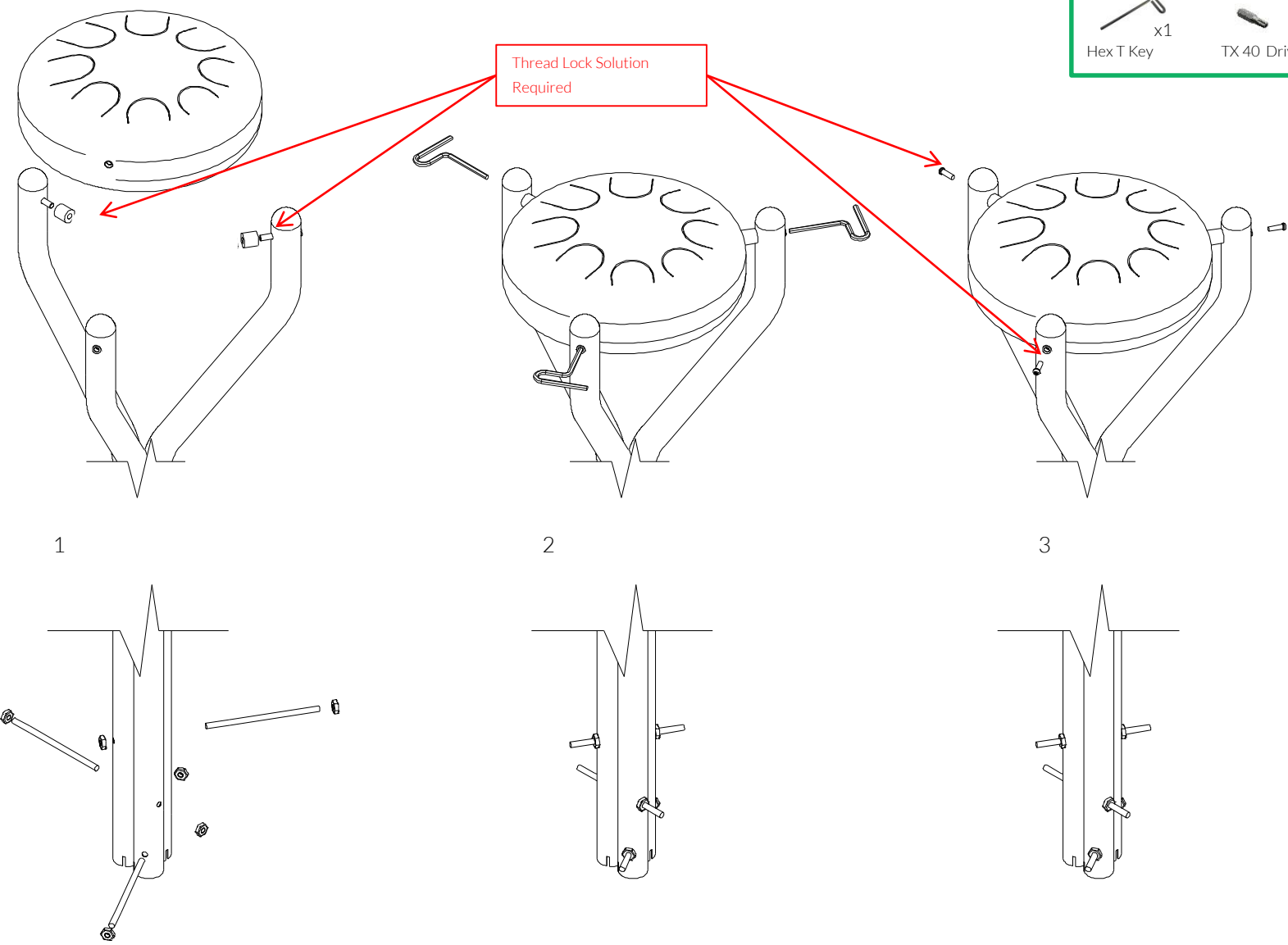

Ground Fix Components:



x3
M10x200 Threaded bar



x6
M10BZP Nut

Spares available from
www.musical-play.com or
from your local distributor

22 Kg
13.4 Kg

Ground Fix Installation

1 Insert M10x 200 Threaded bar into pre drilled holes in Frame of Babel Drum using M10 BZP Nuts

2 Excavate a holes with a 250mm diameter tapering down to 350mm diameter and 450mm depth

3 Compact base of hole with 50mm of aggregate. Lower ground Fix post attached to instrument into hole (check instrument straight and level before filling with concrete)

4 Fill hole with fast drying concrete to manufacturers specifications.

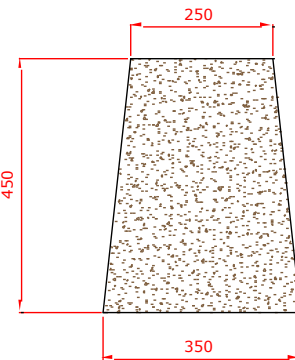
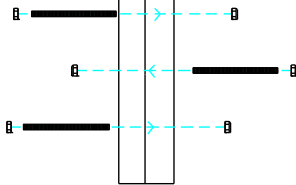
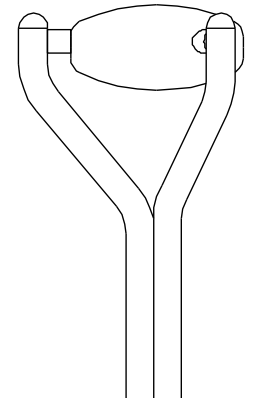
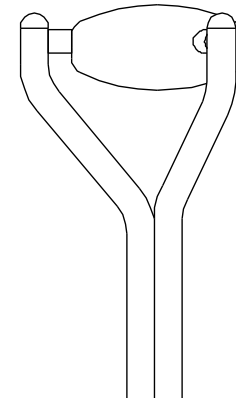
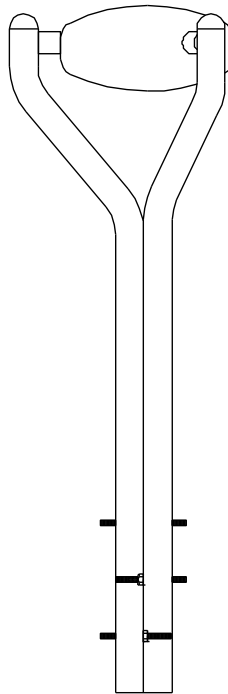
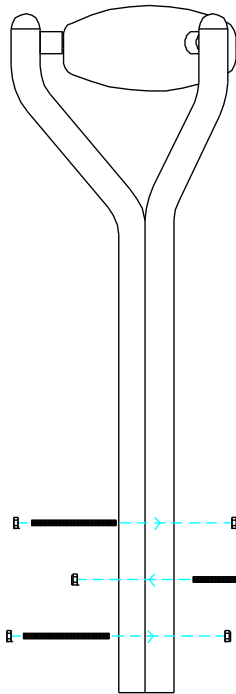

If Drum needs to be positioned lower a deeper hole can be excavated.

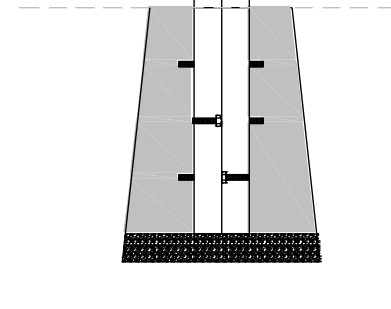
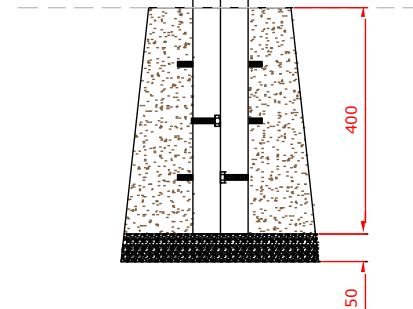

Foundations should not present a hazard. These foundations are recommended as a guide, for more information on foundation details for various surface see Part 7 of BS EN 1176.

Ground Fixed

Babel Drum
Page 3 of 3



Components:



x3

M10x200 Threaded Bar



x6

M10 BZP Nut

Metric Conversion:

50mm/ 2"
250mm/ 10"
350mm/ 14"
400mm/ 16"
450mm/ 18"