

# Installation Instructions

## Surface Fixed

Congas  
Page 1 of 2

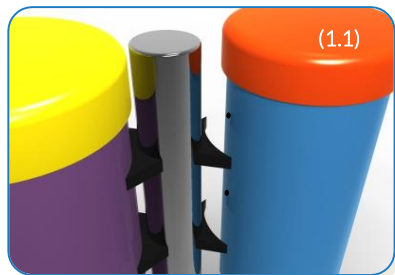

Weight of heaviest part **3.8kg** (Large drum Small Congas)  
 Weight of heaviest part **4.5kg** (Large drum Medium Congas)  
 Weight of heaviest part **5.2kg** (Large drum Large Congas)

1. Attach the steel leg to each of the congas with the M10x50 security screws, square washers and PU mounts. **(1.1)** (See Assembly Guide)

2. Attach Surface Fixing posts to legs **(1.2)** (See Ground Fix Post Installation Sheet)

3. **Locate Plate** in desired location and mark holes to fix to desired surface.

4. Fix to Surface using recommended ground anchors not supplied

5. Make sure all fixings are covered and secure using cover caps provided

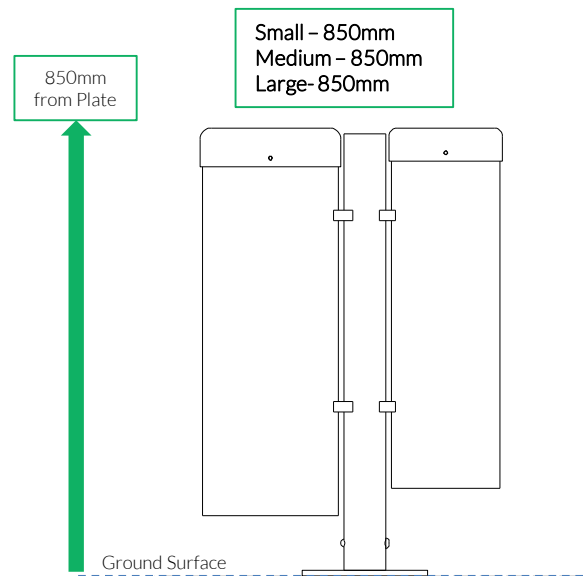
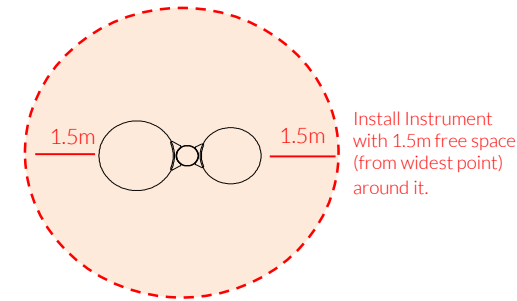

Played with hands

Surface Fix Components:

M10x70 Security Screw x1

M10 Barrel Nut x1

2 Part Cover Cap x4

Ground Anchors not supplied

Spares available from [www.musical-play.com](http://www.musical-play.com) or from your local distributor

14.8 Kg  
15 Kg  
20 Kg

# Assembly Guide PPCONG

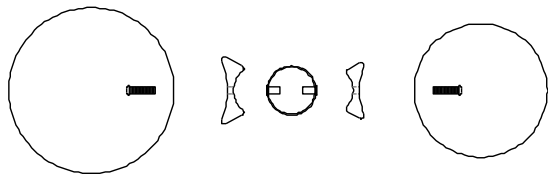

PPCONG PLAN

Thread Lock Solution  
Required (Not Supplied)

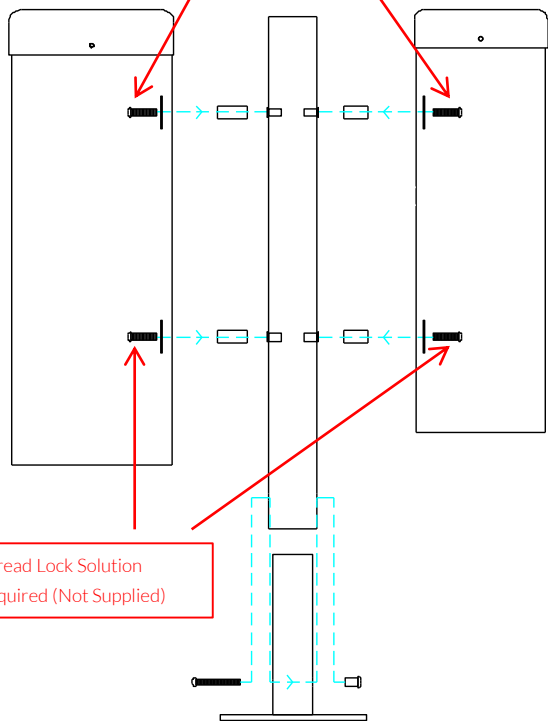

Thread Lock Solution  
Required (Not Supplied)

PPCONG FRONT

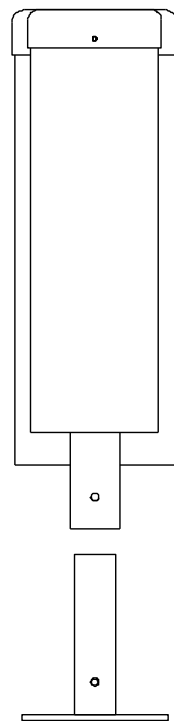



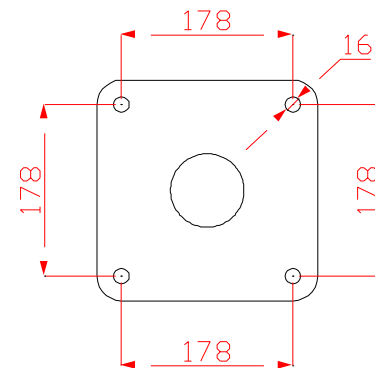



PPCONG SIDE



Tools:

x2  
TX 45 Driver Bit

COMPONENTS LIST:

-  M10x50 Security Screw X4
-  M10x50x3 square washer X4
-  PU MOUNT 200 X2
-  PU MOUNT 250 X2
-  M10x70 Pin torx X1
-  M10 Barrel Nut Pin torx X1

Surface Fixed

Congas  
Page 2 of 2



Instrument Components:



x4

M10x50 Security Screw



x4

M10x50x3 Square washer



x2

200 Mount



x2

250 Mount



Played with hands

Surface Fix  
Components:



x1

M10x70 Security Screw



x1

M10 Barrel Nut



x4

2 Part Cover Cap

Ground Anchors  
not supplied

Spares available from  
[www.musical-play.com](http://www.musical-play.com) or  
from your local distributor

14.8 Kg  
15 Kg  
20 Kg