

Installation Instructions

Ground Fixed

Emperor Chimes
Page 1 of 2

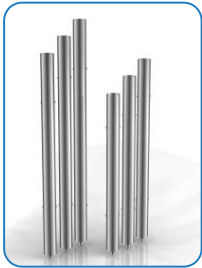

Instrument Components:

Emperor Chimes are pre-assembled

Metric Conversion:

- 100mm/ 4"
- 250mm/ 10"
- 600mm/ 24"
- 1.5m/ 59"
- 1785mm/ 70"
- 2490mm/ 98"

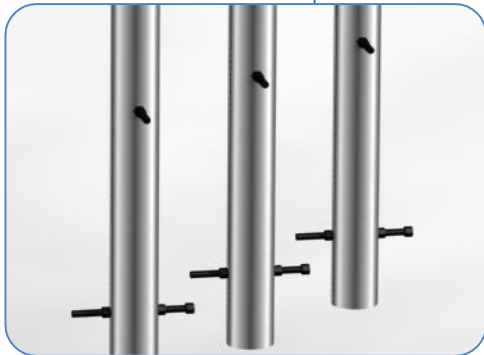
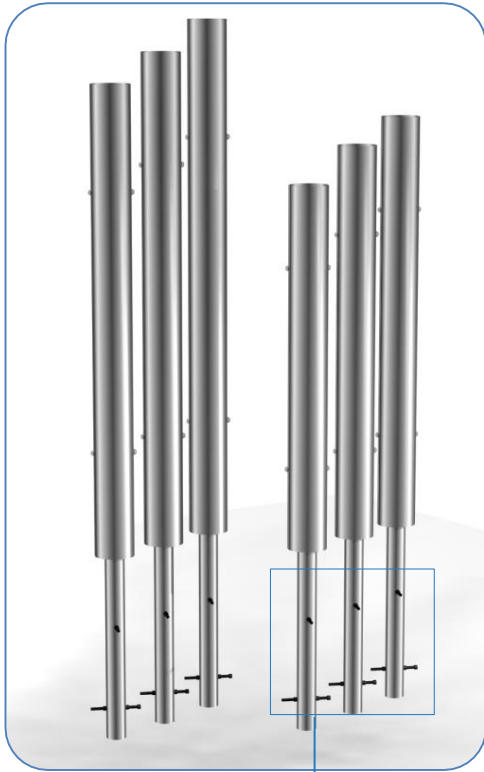

Weight of heaviest part 25kg (XL Chime)

1. Attach Ground Fixing posts to legs (1.2) (See Ground Fix Post Installation Sheet)

2. Excavate 6 holes for Emperor chimes 250mm diameter by 600mm deep in desired location upon decision from customer.

3. Locate (lower) legs into holes making sure they are vertical and level prior to concreting in place. Chimes should be 100mm from ground surface.

4. Once happy with location of the chimes, fill holes using rapid hardening concrete. Be sure to compact concrete around legs and leave to dry according to manufactures guidelines.

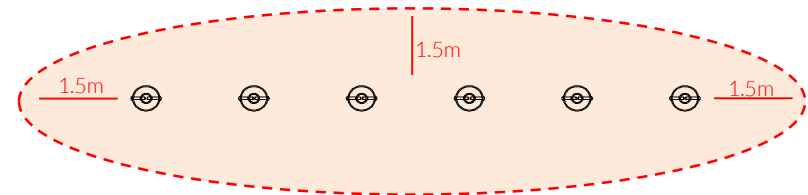

Install Instrument with 1.5m free space (from widest point) around it.

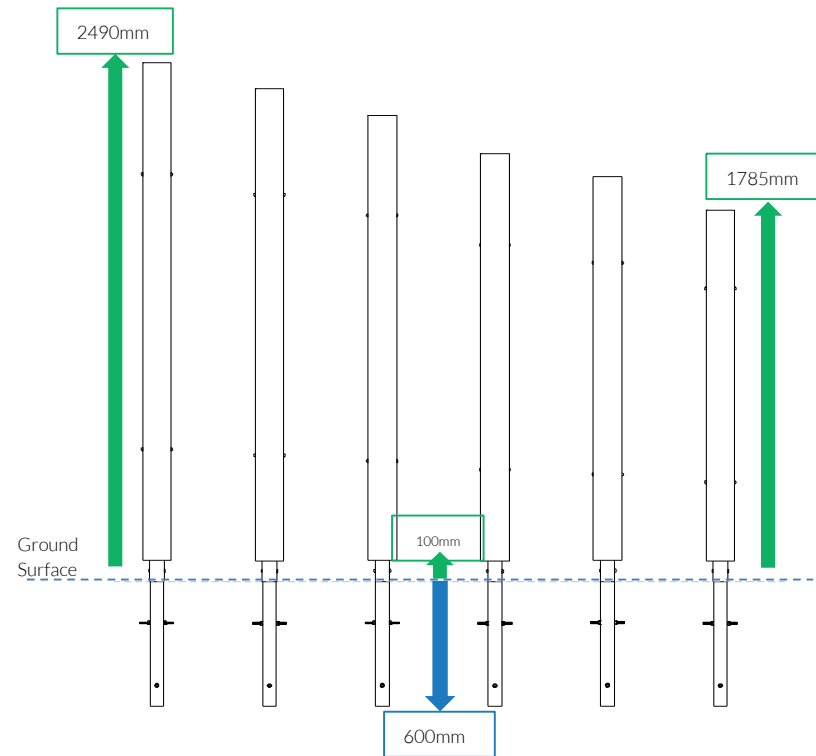

Ground Fix Components:

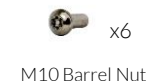

Spares available from www.musical-play.com or from your local distributor

117 Kg

Ground Fix Post Installation

Foundations should not present a hazard. These foundations are recommended as a guide, for more information on foundation details for various surface see Part 7 of BS EN 1176.

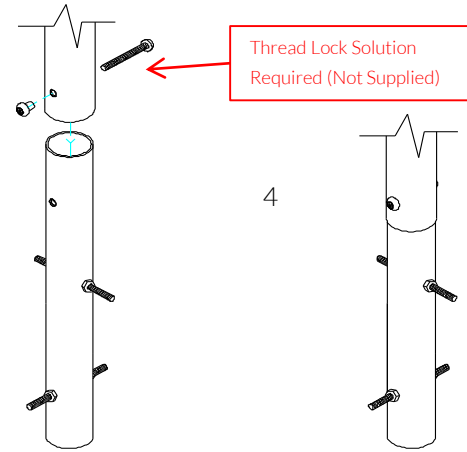

Tools:

x2
TX 45 Driver Bit

Metric Conversion:
50mm/2"
100mm/4"
250mm/10"
350mm/14"
600mm/24"
650mm/26"

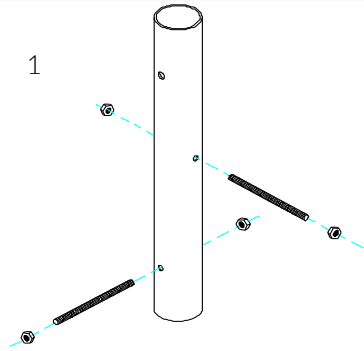

1 Insert M10x 150 Threaded bar into pre drilled holes in Ground Fixing Post

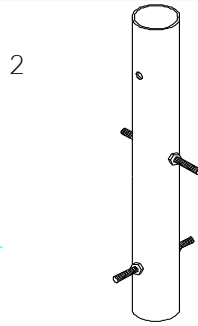

2 Fix M10x 150 Threaded bar in place using M10 Nuts

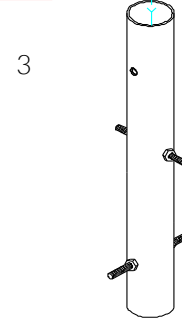

3 Locate the Ground fix Post into the leg of the instrument.

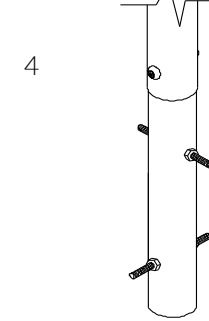

4 Fix instrument to Ground fix post using M10 bolt and Barrel Nut and use **thread locking solution** to prevent fixings working loose.

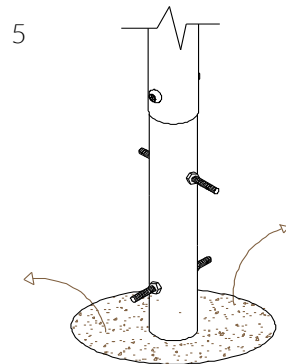

5 Excavate 6 holes with a 250mm diameter tapering down to 350mm diameter and 650mm depth

600mm max depth

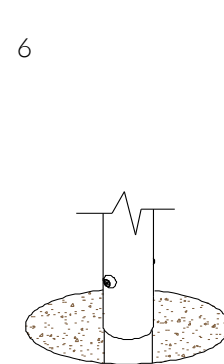

6 Compact base of hole with 50mm of aggregate. Lower ground Fix post attached to instrument into hole (check instrument straight and level before filling with concrete)

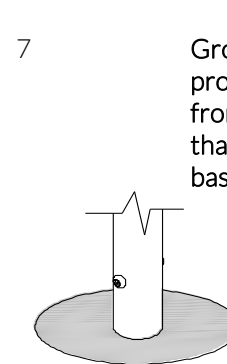

7 Fix hole with fast drying concrete to manufacturers specifications.

Ground fix tube protrudes 300mm from ground surface that inserts into the base of the chime post

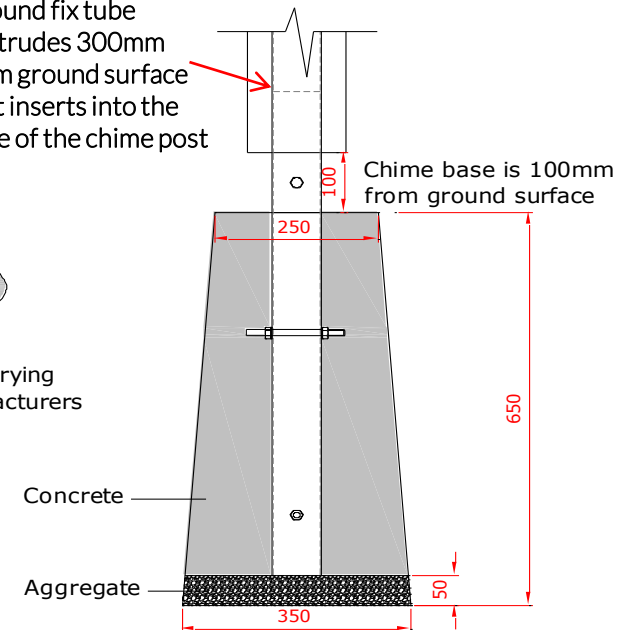

Concrete

Aggregate

Chime base is 100mm from ground surface

650

250

50

350

Ground Fixed

Emperor Chimes
Page 2 of 2

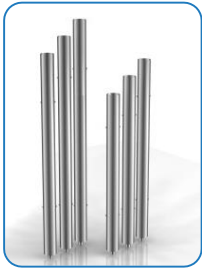

Components:



x12

M10x150 Threaded Bar



x24

M10 BZP Nut



x6

M10 Barrel Nut



x6

M10x50 Security Screw

Thread Lock Solution
Required (Not Supplied)